

导轨内嵌式滑台模组 GSC 120

Guide rail embedded slide module

订购型号代码 Code

GSC 120	L10	500	MS	M40	P3	A001
本体型号 Item NO.	螺杆导程 Ball Screw Lead	行程 Stroke	马达方向 Motor Mounting Position	马达厂牌、功率 Motor Brand, Power Output	限位传感器数量 Photoelectric Sensor	特注式样 Special Order No.
	05 10 20 32	50-1250, 间隔Gap50	MS: 马达直接安装 Straight Motor Mounting ML: 马达左折安装 Left Motor Mounting MR: 马达右折安装 Right Motor Mounting MD: 马达下折安装 Down Motor Mounting	M 三菱 Mitsubishi 20 200W 40 400W P 松下 Panasonic 20 200W 40 400W	P1: 1个 1PC P2: 2个 2PCS P3: 3个 3PCS 未标记: 无 NoMark: NoSensor	



最大静态力和力矩 Max Static Forces And Torques

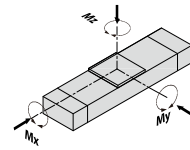

Type	GSC 120
■ M(x) (N·m)	606
■ M(y) (N·m)	606
■ M(z) (N·m)	1168

除了满足最大负载和力矩外,还必须满足以下公式:
All forces and torques relate to the following:

$$\frac{M_x}{M_x \max.} + \frac{M_y}{M_y \max.} + \frac{M_z}{M_z \max.} \leq 1$$

马达安装方向 Motor Mounting Position Version

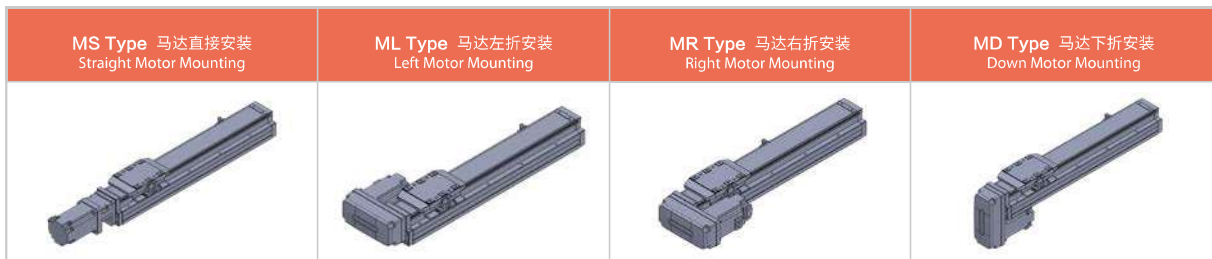

基本规格 Basic Specification

GSC 120						
技术 参数 Technical Parameters	位置重复精度 Repetitive Accuracy (mm)	±0.005				
	螺杆导程 Ball Screw Lead (mm)	5	10	20	32	
	最高速度 Maximum Speed (mm/s)	250	500	1000	1600	
	最大可搬重量 Maximum Payload	水平使用 Horizontal (kg)	110	88	40	30
		垂直使用 Vertical (kg)	33	22	10	8
定额定力 Rated Thrust (N)	1388	694	347	218		
基本 规格 Basic Specification	标准行程 Stroke (mm)	50-1250 mm/ 50 Pitch				
	AC伺服马达容量 AC Servo Motor Output (W)	400				
	滚珠螺杆外径 Ball Screw Diameter (mm)	C7 Ø16				
	联轴器 Coupling (mm)	10 × 14/11				
	原点感应器 Home Sensor	PM-Y45(NPN)				

容许负载力矩表 Allowable Overhang

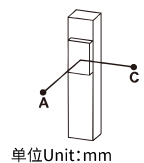
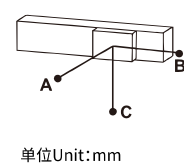
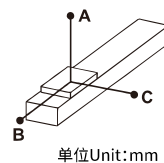

水平安装 Horizontal Installation		A	B	C	壁挂安装 Wall Installation		A	B	C	垂直安装 Vertical Installation		A	C
导程 5 lead	60kg	2850	250	340	导程 5 lead	55kg	280	280	3300	导程 5 lead	15kg	1200	1200
	80kg	2100	180	250		75kg	200	195	2400		22kg	820	820
	110kg	1500	120	170		110kg	130	125	1550		33kg	550	550
导程 10 lead	30kg	2850	490	600	导程 10 lead	35kg	400	410	2500	导程 10 lead	10kg	1600	1600
	50kg	1700	280	350		55kg	245	250	1550		14kg	1150	1150
	88kg	950	140	190		88kg	150	150	950		22kg	730	730
导程 20 lead	10kg	3400	1250	1400	导程 20 lead	12kg	900	1070	3000	导程 20 lead	7kg	1800	1800
	22kg	1650	550	620		20kg	550	630	1800		10kg	1250	1250
	40kg	900	290	330		40kg	260	300	900		-	-	-
导程 32 lead	15kg	1100	570	550	导程 32 lead	15kg	440	570	1050	导程 32 lead	5kg	1600	1600
	25kg	620	330	320		30kg	210	270	520		8kg	1000	1000
导程 32 lead	30kg	520	270	260	导程 32 lead	-	-	-	-	导程 32 lead	-	-	-

GSC 120 导轨内嵌式滑台模组

Guide rail embedded slide module

GSC 120-MS 马达直接安装 Straight Motor Mounting

2D&3D文档下载请至
www.limonrobot.cn

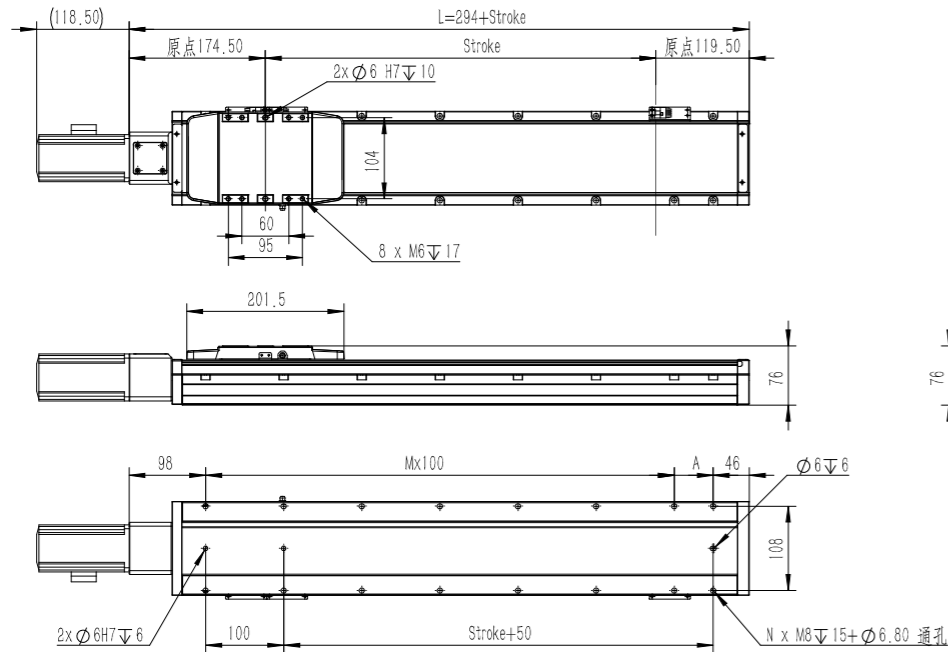

行程 Stroke(mm)	50	100	150	200	250	300	350	400	450	500	550	600	650	700	750	800	850	900	950	1000	1050	1100	1150	1200	1250
L	344	395	444	494	544	594	644	694	744	794	844	894	944	994	1044	1094	1144	1194	1244	1294	1344	1394	1444	1494	1544
A	100	50	100	50	100	50	100	50	100	50	100	50	100	50	100	50	100	50	100	50	100	50	100	50	100
M	1	2	2	3	3	4	4	5	5	6	6	7	7	8	8	9	9	10	10	11	11	12	12	13	13
N	6	8	8	10	10	12	12	14	14	16	16	18	18	20	20	22	22	24	24	26	26	28	28	30	30
重量 Weight(kg)	5.05	5.4	5.75	6.1	6.45	6.8	7.15	7.5	7.85	8.2	8.55	8.9	9.25	9.6	9.95	10.3	10.65	11	11.35	11.7	12.05	12.4	12.75	13.1	13.45

GSC 120-ML 马达左折安装 Left Motor Mounting

2D&3D文档下载请至
www.limonrobot.cn

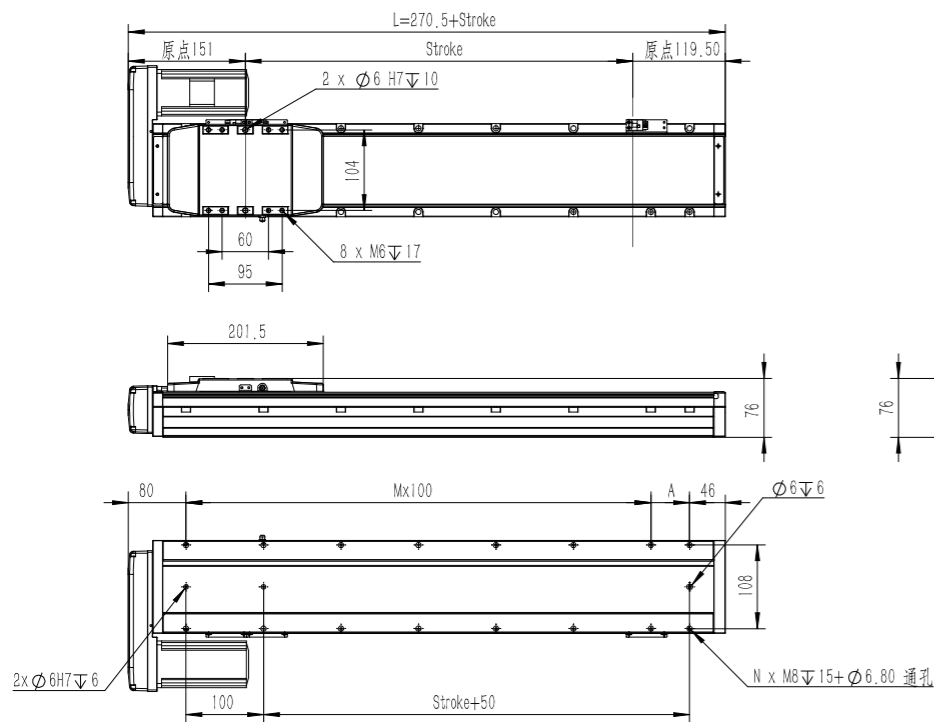

行程 Stroke(mm)	50	100	150	200	250	300	350	400	450	500	550	600	650	700	750	800	850	900	950	1000	1050	1100	1150	1200	1250
L	320.5	380.5	430.5	480.5	530.5	580.5	630.5	680.5	730.5	780.5	830.5	880.5	930.5	980.5	1030.5	1080.5	1130.5	1180.5	1230.5	1280.5	1330.5	1380.5	1430.5	1480.5	1530.5
A	100	50	100	50	100	50	100	50	100	50	100	50	100	50	100	50	100	50	100	50	100	50	100	50	100
M	0	1	1	2	2	3	3	4	4	5	5	6	6	7	7	8	8	9	9	10	10	11	11	12	12
N	4	6	6	8	8	10	10	12	12	14	14	16	16	18	18	20	20	22	22	24	24	26	26	28	28
重量 Weight(kg)	5.21	5.56	5.91	6.26	6.61	6.96	7.31	7.66	8.01	8.36	8.71	9.06	9.41	9.76	10.11	10.46	10.81	11.16	11.51	11.86	12.21	12.56	12.91	13.28	13.61

导轨内嵌式滑台模组 GSC 120

Guide rail embedded slide module

GSC 120-MR 马达右折安装 Right Motor Mounting

2D&3D文档下载请至
www.limonrobot.cn

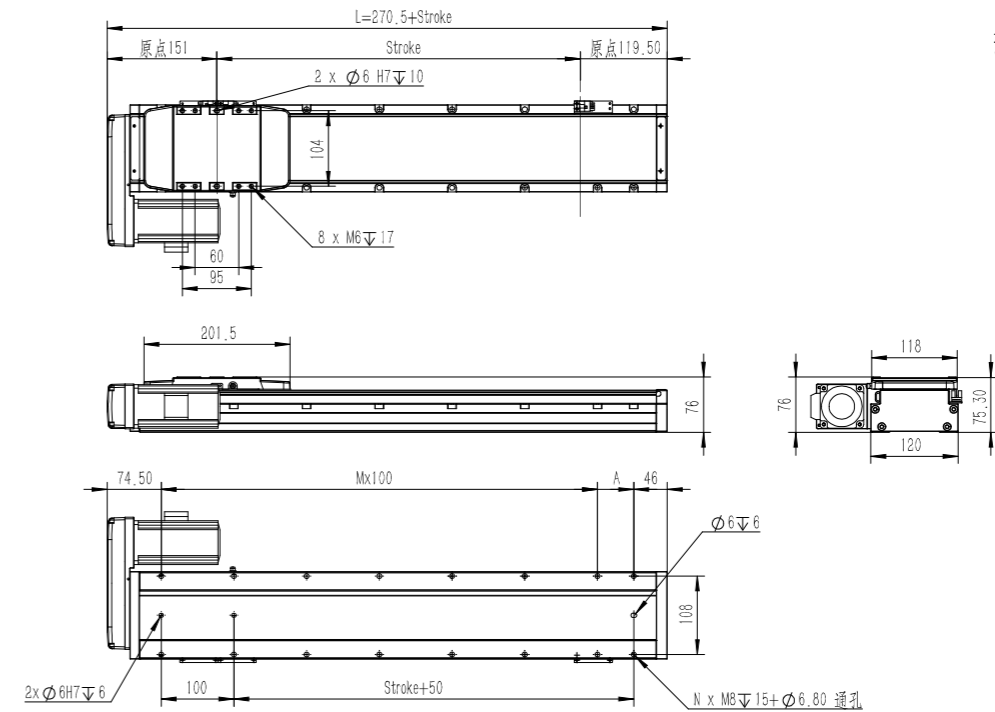

行程 Stroke(mm)	50	100	150	200	250	300	350	400	450	500	550	600	650	700	750	800	850	900	950	1000	1050	1100	1150	1200	1250
L	320.5	380.5	430.5	480.5	530.5	580.5	630.5	680.5	730.5	780.5	830.5	880.5	930.5	980.5	1030.5	1080.5	1130.5	1180.5	1230.5	1280.5	1330.5	1380.5	1430.5	1480.5	1530.5
A	100	50	100	50	100	50	100	50	100	50	100	50	100	50	100	50	100	50	100	50	100	50	100	50	100
M	0	1	1	2	2	3	3	4	4	5	5	6	6	7	7	8	8	9	9	10	10	11	11	12	12
N	4	6	6	8	8	10	10	12	12	14	14	16	16	18	18	20	20	22	22	24	24	26	26	28	28
重量 Weight(kg)	5.21	5.56	5.91	6.26	6.61	6.96	7.31	7.66	8.01	8.36	8.71	9.06	9.41	9.76	10.11	10.46	10.81	11.16	11.51	11.86	12.21	12.56	12.91	13.28	13.61

GSC 120-MD 马达下折安装 Down Motor Mounting

2D&3D文档下载请至
www.limonrobot.cn

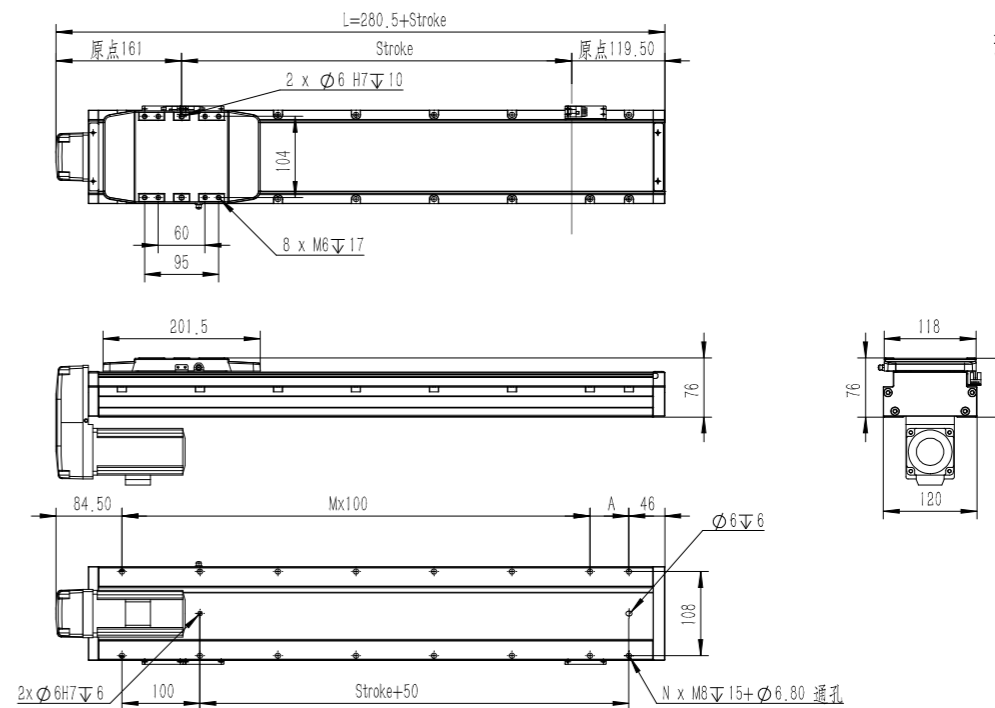

行程 Stroke(mm)	50	100	150	200	250	300	350	400	450	500	550	600	650	700	750	800	850	900	950	1000	1050	1100	1150	1200	1250
L	320.5	380.5	430.5	480.5	530.5	580.5	630.5	680.5	730.5	780.5	830.5	880.5	930.5	980.5	1030.5	1080.5	1130.5	1180.5	1230.5	1280.5	1330.5	1380.5	1430.5	1480.5	1530.5
A	100	50	100	50	100	50	100	50	100	50	100	50	100	50	100	50	100	50	100	50	100	50	100	50	100
M	0	1	1	2	2	3	3	4	4	5	5	6	6	7	7	8	8	9	9	10	10	11	11	12	12
N	4	6	6	8	8	10	10	12	12	14	14	16	16	18	18	20	20	22	22	24	24	26	26	28	28
重量 Weight(kg)	5.21	5.56	5.91	6.26	6.61	6.96	7.31	7.66	8.01	8.36	8.71	9.06	9.41	9.76	10.11	10.46	10.81	11.16	11.51	11.86	12.21	12.56	12.91	13.28	13.61